



ER-V1 User Manual

Table of Contents

1. Quick Start Guide.....	2
2. Introduction.....	3
3. Controls.....	4
4. Warnings.....	6
5. Features.....	7
6. Power Sources.....	8
6.1 Best Practices for Charging.....	8
6.2 DC and AC Power.....	8
6.3 Solar Power.....	9
6.4 Hand Crank Power.....	9
6.5 Dry Smart Battery AAA Battery Power.....	10
6.6 Power Consumption.....	11
7. Operation.....	11
7.1 Flashlight Operation.....	11
7.2 Emergency Siren with Light Flasher.....	11
7.3 Radio Operation.....	12
7.4 Time.....	12
7.5 Radio Band Mode.....	13
7.5.1 AM/FM Radio Tuning.....	13
7.5.2 Preset Channels.....	14
7.5.3 Weather Band Tuning.....	14
7.5.4 Weather Alert Mode.....	14
7.6 Smart Phone and iPad/ Tablet Operation.....	15
7.7 Low Battery Indication.....	15
7.8 Audio Output / Head Phones.....	16
7.9 Resetting the radio.....	16
8. Care and Maintenance.....	17
8.1 Battery Maintenance.....	17
8.2 General Care and Maintenance.....	18
9. Specifications.....	18
10. Troubleshooting Guide.....	18
11. Liability Disclaimer.....	22
12. Warranty Information.....	22
13. FCC Statement.....	23
14. Battery Recycle Statement.....	24

1. Quick Start Guide

Open the battery door and connect the rechargeable battery to the main board. Close the battery door and crank the dynamo to activate the ER-V1.



If the ER-V1 does not operate after pulling the battery tab or anytime during normal operation, fully charge and reset the ER-V1 by inserting an open ended paper clip into the reset hole.

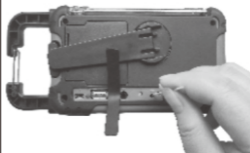

Maintenance:

1. Periodically charge the ER-V1 every few months.

This will extend the battery life and provide a fully charged when an emergency occurs.

2. The solar collector extends battery life but will not fully charge the ER-V1.

3. Remove, inspect and clean the ER-V1 battery contacts every few months with a cotton cloth. Inspect the battery for corrosion or leakage.



Charging Smart Phone or iPad/ Tablet:

1. Disconnect from AC or USB power.
2. Press and hold the Power button  for 3 seconds until the **PHONE** charging icon is displayed on the screen.
3. Plug in your smart phone or iPad/Tablet.



Problems? Questions?

Email: support@baofengtech.com

2. Introduction

Thank you for your purchase of the BTECH ER-V1
Emergency Solar Hand Crank Radio

3. Controls

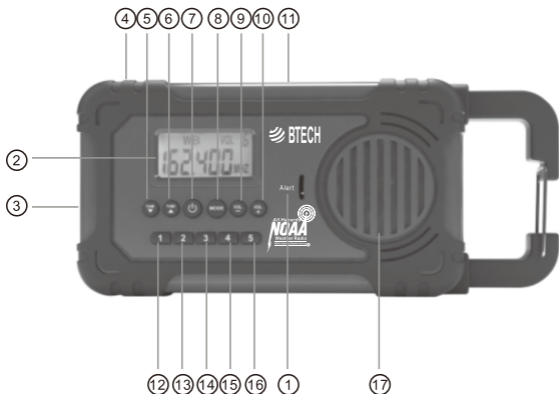

No	Description	No	Description
1	Weather Alert Indicator	8	Radio Mode Select and Clock Set button
2	LCD Display	9	Volume Down (-) button
3	Flashlight	10	Volume Up (+) button
4	Flashlight ON/OFF button Emergency Siren / Flasher Light button	11	Solar Panel
5	Clock/Radio Tune Down (▼) button	12-16	Station Preset buttons 1-5
6	Clock/Radio Tune Up (▲) button	17	Speaker
7	Power On/Standby (⏻) Smart Phone / Radio On		

Figure 1

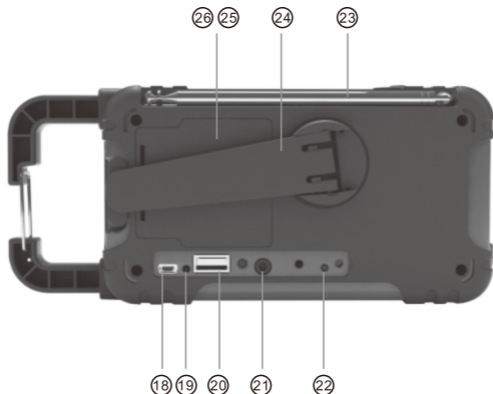

No	Description	No	Description
18	Mini USB DC Input Port (under the Rubber Dust Cover)	23	Telescopic Antenna
19	Charging Indicator (under the Rubber Dust Cover)	24	Crank Handle
20	USB Charging Port (under the Rubber Dust Cover)	25	AAA battery compartment
21	Headphone Jack (under the Rubber Dust Cover)	26	Rechargeable battery compartment
22	Reset button (under the Rubber Dust Cover)		

Figure 2

4. Warnings

When used in the directed manner, this unit has been designed and manufactured to assist with your personal safety. However, improper use can result in potential electrical shock or fire hazards. Please read all safety and operating instructions carefully before installation and use, and keep these instructions handy for future reference. Take special note of all warnings listed in these instructions.

Before using this product, please read the following warning and cautions:

1. Read these instructions – All the safety and operating instructions should be read before the ER-V1 is operated.
2. Keep these instructions – the safety and operating instructions should be kept for future reference.
3. Heed all warnings – All warnings on the device and in the operating instructions should be adhered to.
4. Follow all instructions – All operation and use instructions should be followed.
5. Do not use this item in water – the ER-V1 should not be used in water; for example, near a bath tub, washbowl, kitchen sink, laundry tub, in a wet basement, or near a swimming pool when plugged into an external power source, such as AC power.
6. Clean only with dry cloth – the ER-V1 should be cleaned only as recommended by the manufacturer.
7. Do not use near any heat sources such as radiators, heat registers, stoves, or devices (including amplifiers) that produce heat.
8. Do not place near a fire. The battery can explode.
9. Only use attachments / accessories recommended by the manufacturer.
10. Refer all servicing to qualified service personnel. Servicing is required when the ER-V1 has been damaged in any way, such as submersion in water, or the unit has been dropped.
11. The ER-V1 shall not be exposed to dripping or splashing water and no object filled with liquids such as vases shall be placed on the ER-V1.

-
12. Unplug immediately if liquid has been spilled on or any object has fallen into the ER-V1.
 13. Power Sources -the ER-V1 should be connected to a power supply while charging
 14. Use suggested adapter as described in the operating instructions or as marked on ER-V1. Do not overload the wall outlet.
 15. Danger of explosion if the battery is incorrectly replaced. Replace only with the same or equivalent type.
 16. Do not attempt to dismantle, open or repair this product yourself. If a fault occurs, seek advice from BTECH support. Only the rechargeable battery can be replaced or serviced.
 17. Only operate within specified temperature range (32°F to 131°F).
 18. Do not store the AAA batteries for extended periods of time. They may leak or rupture and cause damage to the ER-V1.

▲ **Lithium Battery Safety Instructions**

- Do not burn or bury batteries. Do not puncture or crush. Do not disassemble. Recycle Lithium batteries. Do not dispose of in the trash.
- If the electrolyte in the cells should get on your skin, thoroughly wash with soap and water. If in the eyes, rinse thoroughly with cool water. Immediately seek medical attention.
- Charge batteries on a fireproof surface away from flammable items or liquids.

▲ **Hand Crank Warning**

To prevent overheating of the dynamo hand crank and permanent damage, do not crank faster than approximately two revolutions per second. Do not crank continuously for more than two minutes. After two minutes, allow one minute of rest before cranking again.

5. Features

The ER-V1 includes the following features:

- Super bright 35 lumens LED flashlight
- Emergency Siren

-
- AM/FM with Weather Band Feature
 - Weather Alert Feature (public alert certified)
 - Emergency smart phone/tablet/USB charger
 - Backlit digital display
 - Clock
 - Audio output (headphones)

6. Power Sources

The ER-V1 can be powered from the following sources:

- DC power from a USB power source, such as a computer
- AC power by adding a USB to AC adapter (not included)
- DC car charger by adding a USB to DC car adapter (not included)
- Solar power
- Hand crank power
- Three AAA batteries (not included)
- 2000mAh rechargeable Lithium battery(integrated)

NOTE: There is a charging LED on the back of the ER-V1. (Figure2, reference 19). The LED indicator is solid red during charging. When fully charged, the LED turns solid green.

6.1. Best Practices for Charging

We recommend periodically charging the ER-V1 completely through the mini USB power input port (from your computer, AC adapter or DC converter) every few months. Remove from power source when fully charged.

Please take AAA batteries out if you leave it connected to the USB power source all of the time.

The solar panel will not completely charge your unit and is intended to extend the existing battery charge.

6.2. DC and AC Power

Prior to using the ER-V1, we recommend fully charging the rechargeable battery through the USB Power Input (Figure 2). This may take up to four hours.

Connect the power input cable (Figure 3) to the USB mini jack and the other end to the USB or AC power source. The battery charge indicator light is red when

charging (Figure 2, reference 19). Continue to charge the radio for several hours or until the charging light turns solid green. the ER-V1 is now ready for use.

NOTE: Use a 5.0V USB power source (from a computer or appropriate AC or DC adapter). Over-voltage may result in damaging the ER-V1.

6.3. Solar Power

Place the ER-V1 in direct (or indirect) sunlight with the solar panel facing upwards. The red battery charging indicator will flash when charging, as shown in Figure 1.

NOTE: If the display heats up outside the operational range, the display will fade, but it will not damage the display.

NOTE: The solar panel will not completely charge your unit and is intended to extend the existing battery charge. The solar panel efficiency is significantly impacted by direct vs. indirect sunlight, angle of the solar panel, angle of the sun and weather conditions, including your latitude, time of year (winter vs. summer), time of day, and cloud cover.

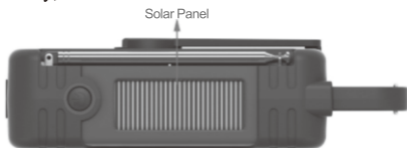

Figure 4

6.4. Hand Crank Power

To operate the hand crank, perform the following:

1. Lift the hand crank from the cradle, as shown in Figure 2.
2. Turn the hand crank clockwise at about two cranks per second for two minutes. The battery charging light is red when charging, as shown in Figure 1. After two minutes, rest for two minutes to extend the life of the hand crank and repeat.

-
3. For subsequent charges, turn the hand crank for one minute to produce 70 minutes of continuous light for the LED flashlight, or 16-20 minutes of continuous radio usage (subject to volume) or approximately 3-5 minutes of talk time on the smart phone (your results may vary due to phone variations).

6.5. Dry AAA Battery Power

The ER-V1 also includes the option to power from 3 x AAA batteries as a back up to the rechargeable battery source. This is convenient if you have drained the rechargeable battery source and you wish to avoid hand cranking the ER-V1.

Note that the AAA batteries will not provide enough current to charge some smart phones and PDAs and is intended for the flashlight and radio only.

1. Open the Battery Door on the back of the ER-V1.
2. Insert 3 x AAA alkaline batteries (not included) and close the battery door.

NOTE: For optimum performance, DURACELL batteries are recommended.

3. Follow the polarity diagrams shown in the battery compartment.

NOTE: Make certain the batteries are installed correctly. The wrong polarity may damage the ER-V1.

WARNING:

- Do not mix old and new batteries.
- Do not mix alkaline, standard (carbon-zinc) or rechargeable (nickel-cadmium) batteries.
- Only batteries of the same or equivalent type as recommended are to be used
- If the ER-V1 is off, not to be used for an extended period of time, remove the batteries. Old or leaking batteries can cause damage to the ER-V1 and may void the warranty.
- Do not dispose of batteries in fire, batteries may explode or leak.

6.6. Power Consumption

The ER-V1 includes an integrated 3.7V rechargeable Lithium large capacity battery (2000 mAh) as the primary energy storage, but different operational modes result in significantly varying power consumption requirements. Here is a general guide on power consumption, typical user operation and recommended power sources.

Mode	Typical User Operation	Power Consumption	Recommend Power Source
Flashlight	Emergency or remote use	Low	Solar, Hand Crank, AAA Batteries, Lithium battery
AM/FM/Weather Band Radio	Emergency or remote use	Low	Solar, Hand Crank, AAA Batteries, Lithium battery
Weather Alert	Continuous monitoring(1)	High	AC, USB (from computer)
Smart phone charging	Short term emergency use(2)	High	AC, USB (from computer), Hand Crank, Lithium battery

1. The weather alert mode consumes a significant amount of power because it is constantly scanning for the emergency 1050 Hz tone from the National Weather Service. We recommend connecting the power input to a USB computer port or the USB to AC converter for continuous alert operation (reference Section 12). Otherwise, you must rely on hand crank power in this mode when no power is available.
2. The AAA batteries may not provide enough current to charge a smart phone.

7. Operation

7.1. Flashlight Operation

Turn the light on and off with the light switch on the top of the emergency radio (Figure 1).

7.2. Emergency Siren with Light Flasher

To sound the emergency siren with light flasher, press and hold the flashlight switch for 3 seconds. To disable, press the flashlight switch again.

7.3. Radio Operation

The ER-V1 includes a digital LCD display (Figure 5) with backlighting and the following push button controls:

- **POWER**  : Turns the radio on and off. Transitions from clock display to radio tuner display.
- **MODE**: Switches the radio band between AM, FM, weather band, and weather band alert mode.
- **TUN▲**: Adjusts the radio frequency up
- **TUN▼**: Adjusts the radio frequency down
- **VOL+**: Adjusts the radio volume up
- **VOL-**: Adjusts the radio volume down
- **Preset 1,2,3,4,5**: Switch to programmed preset channels.

NOTE: The backlight will automatically turn off if no buttons are pressed for 20 seconds.

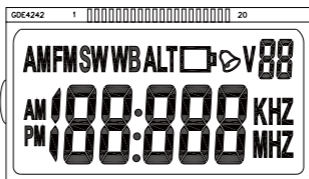

Figure 5

7.4. Time

When first powered up, the time will default to 12:00 AM.

1. **Set 12Hr/24Hr Mode.** Press and hold the **MODE** button for two seconds to enter the time setting mode. 12 Hr will begin flashing. Press the **TUN+** button to switch between 12 hour and 24 hour time mode. Press the **MODE** button to proceed to the next step.
2. **Set Hour.** Press the **TUN▲** or **TUN▼** to adjust the hour up or down. Hold the **TUN** button to change rapidly. Press the **MODE** button to proceed to the next step.
3. **Set Minute.** Press the **TUN▲** or **TUN▼** to adjust the minute up or down. Hold the **TUN** button to change rapidly. Press the **MODE** button to exit the time setting mode.

7.5. Radio Band Mode

NOTE: Radio reception is dramatically reduced when charging from USB. Disconnect USB power when listening to the radio.

Press the **POWER** button to turn the radio on and transition from the time mode.

The ER-V1 will default to the **AM** band(or the last radio band since power up). Press the **MODE** button to change to the **FM** band. Press the **MODE** button to change to the **SW** band. Press the **MODE** button to change to the Weather Band(**WB**). While displaying the Weather Band, press the **MODE** button again to change to Weather Band Alert mode (the **ALT** symbol will appear).

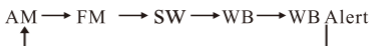

Figure 6

NOTE: Radio interference will be present while charging the Emergency Solar Hand Crank Radio. For the best reception, there is a telescoping antenna. Extend the antenna and change the position if the reception is weak.

7.5.1. AM/FM/SW Radio Tuning

When the ER-V1 is turned on, press the **TUN▲** button to increase the frequency and press the **TUN▼** button to decrease the frequency.

To auto scan, press and hold the **TUN(▲ or ▼)** key for at least one second and the radio will automatically tune to next radio station with sufficient reception. you can edit the Shortwave band range when you are in the SW radio mode. Once in the SW radio mode, press and hold the **MODE** button for two seconds to be able to enter the SW band field (S1~S8).press the **TUNE** buttons to select your preferred setting S1~S8. Press the **MODE** button to confirm the setting

7.5.2. Preset Channels

There are five preset channels. To set the preset channels, tune to your favorite AM/FM/channel(s) and press, and hold the preset button (1-5) until the screen flashes.

7.5.3. Weather Band Tuning

There are seven distinct weather channels. The frequencies are 162.400 MHz, 162.425 MHz, 162.450 MHz, 162.475 MHz, 162.500 MHz, 162.525 MHz, and 162.550 MHz.

For a complete list of weather radio broadcasting stations, please visit the National Weather Service website:

<https://www.weather.gov/nwr/Maps>

Our recommendation is to tune to the station with the best reception using the **TUN▲** button. You will hear the “Voice of the National Weather Service”, an automated voice that provides forecast information, weather statements, watches, and warnings.

7.5.4. Weather Alert Mode

You can silence the ER-V1 and enter the weather alert mode. The ER-V1 will remain in standby mode until there is a weather statement, watch, or warning. To activate the Weather Alert Mode, tune to your local station as defined in the previous section.

Press the **MODE** button until the **ALT** symbol will be displayed. The **ALT** symbol will continue to be displayed until there is a weather statement, watch, or warning. In the event of an alert, the alert light will flash and the ER-V1 will sound (with the voice of the National Weather Service). To disable the alert light, press any key. To disable the alert light but continue in alert mode, press and hold the **MODE** button for two seconds.

To verify you have reception in your area, the National Weather Service (NWS) normally runs tests each Wednesday between 10 a.m. and noon local time. Tests may occur at other days and times when there is a threat of severe weather in the listening area or for other reasons.

When a weather alert occurs, the ER-V1 will sound and the weather alert light will flash on the front of the emergency radio. Press the power button  to disable the weather alert.

NOTE: If battery power is low, the ER-V1 will exit the weather alert mode and enter the time display mode.

7.6. Smart Phone and Tablet Operation

Because smart phone batteries vary in their current ratings, we cannot specify charging rates or usage time. 10 to 15 minutes of cranking may result in 1 or more minute of talk-time, but your results may vary.

To charge the smart phone or music player device:

1. Disconnect the unit from AC or USB power (if it is connected).
2. Press and hold the Power button  for 3 seconds until the **PHONE** charging icon is displayed on the screen. This feature will turn off all radio modes to conserve power.
3. Lift the rubber tab on the right of the ER-V1 to expose the connectors, as shown in Figure 2.
4. Plug the smart phone charging cable (Figure 3) into the ER-V1 to charge through the USB output (Figure 2 reference 20). Plug your smart phone charge through the USB output USB power output port.
5. If the phone does not begin charging, disconnect the phone and begin turning the hand crank. When charging a smart phone via the smart phone charger, it is important to turn the crank at least two revolutions per second. After two minutes of cranking at two revolutions per second, wait two minutes to begin cranking again. This will extend the crank life.

NOTE: You may receive a charging compatibility error on your smart phone, but your device may still charge and it will not harm your device.

7.7. Low Battery Indication

When the battery voltage is less than 3.0V, the low battery indication will be displayed:



The ER-V1 will not operate in a low battery condition. If the battery drains quickly or the low battery indication displays, it is time to replace your battery (typically 1-3 years of operation).

7.8. Audio Output / Head Phones

The ER-V1 includes an audio output jack. This allows you to listen with headphones or connect to an auxiliary input source, such as an amplifier.

CAUTION: Guard your ears against hearing damage. When listening with headphones, start at the lowest volume and gradually increase until you can hear it comfortably and clearly.

Read this Important Information before Using Your Earbuds:

- Avoid extended play at very high volume as it may impair your hearing.
- If you experience ringing in your ears, reduce the volume or shut off the ER-V1
- Keep the volume at a reasonable level even if your headset is an open-air type designed to allow you to hear outside sounds. Please note that excessively high volume may still block outside sounds.

7.9. Resetting the Emergency Radio

If the ER-V1 experiences a power surge or electric shock, it is possible that the internal micro-controller may lock up and the ER-V1 will not respond to any commands from the panel controls. In this event, use a straightened paper clip, toothpick or similar objects to press the RESET button located on the back of the ER-V1 (see figure 7 on next page). The reset operation clears the system memory to factory default and all of your previous settings will be erased.

CAUTION: Do not use a sharp or pointed object to press the reset button. It may damage the reset switch inside the ER-V1.

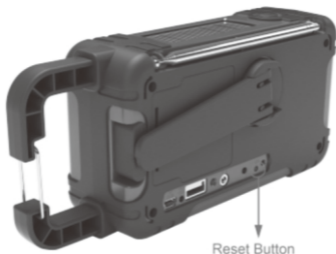

Figure 7

8. Care and Maintenance

8.1. Battery Maintenance

To maintain the battery:

- Periodically charge the battery to extend battery life.
- Switch off power after radio use to extend battery life.
- Remove the AAA batteries for extended storage to prevent battery leakage.
- Remove, inspect, and clean the radio battery contacts every few months with a cloth. Inspect the battery for corrosion or leakage

The battery is an integrated rechargeable 3.7V/2000mAh lithium battery. Before long term storage, please open the battery door to disconnect the rechargeable lithium battery from the main board.

8.2. General Care and Maintenance

- Do not tamper the internal components of the ER-V1.
- Clean your unit with a damp (never wet) cloth. Solvent or detergent should never be used.

-
- Avoid leaving your unit in direct sunlight or in hot, humid or dusty places.
 - Keep your unit away from heating appliances and sources of electrical noise such as fluorescent lamps or motors.

9. Specifications

Battery Power:

3.7V / 2000 mAh rechargeable lithium battery (integrated)
or 3 x AAA batteries

Radio Bands:

AM: 520 KHz to 1710 KHz

FM: 87.5 MHz to 108 MHz

Weather Band : 162.500 to 162.550 MHz

SW: 5.950MHz to 21.850 MHz

SW1: 5.950 MHz to 6.200 MHz

SW2: 7.100 MHz to 7.300 MHz

SW3: 9.500 MHz to 9.90MHz

SW4: 11.650 MHz to 12.050 MHz

SW5: 13.600 MHz to 13.800 MHz

SW6: 15.100 MHz to 15.600 MHz

SW7 : 17.500 MHz to 17.900 MHz

SW8: 21.450 MHz to 21.850 MHz

Flashlight:

35 lumens Flashlight

Siren:

125 db

Size and Dimensions:

Dimensions: 6.0" x 3.5" x 2.0"

Weight: 15 ounces

Temperature Range:

Working temperature range: 32 to 131 °F (0 to 55 °C)

Storage temperature range: 14 to 140 °F (-10 to 60 °C)

10. Troubleshooting Guide

If your question is not answered here, you can contact us as follows:

1. Email Support: support@baofengtech.com

Problem	Solution
The ER-V1 will not power up.	<ul style="list-style-type: none"> ● Make sure the rechargeable battery is connected to main board correctly. ● Remove, inspect and clean The ER-V1 battery contacts every few months with a cloth. Inspect the battery for corrosion or leakage. ● Press the reset button with a paperclip.
Phone generates an error message when plugged into the ER-V1.	A lower voltage output may result in error messages on the phone but should still charge the phone.
My Ipod / iPhone does not display the charge signal.	<p>The output voltage of the ER-V1 is lower than the operating voltage of the IPod / iPhone and will not charge these.</p> <p>The ER-V1 is only intended for emergency charges and not for topping off already charged batteries</p>

Problem	Solution
<p>The Weather Band reception is poor.</p>	<ul style="list-style-type: none"> ● Weather band reception can be poor inside a metal building, structure, or where electronic noise is present. Try moving outside to improve reception. ● Check local reception by moving to a different location and testing the weather band reception. ● Radio reception is dramatically reduced when charging from USB. Disconnect USB power when listening to the ER-V1.
<p>The ER-V1 will not fully charge my smart phone.</p>	<p>Charging a smart phone through the Phone Charger Jack is intended for emergency purpose only. It is not intended for recharging fully a discharged battery. Smart phone battery capacity significantly exceeds the battery capacity of the ER-V1.</p> <p>Therefore, a fully charged radio will only partially charge a smart phone or Tablet device. After the battery stops charging the ER-V1, disconnect the ER-V1 and begin cranking if a DC power source is not available.</p>
<p>I never receive weather alerts.</p>	<p>Verify you can receive the test alert from the National Weather Service on Wednesday as described in the weather alert section of this manual.</p> <p>Verify you have tuned to the local weather channel for your area and you have reception before activating the weather alert feature. Make sure you have good weather radio reception. If your radio reception is poor, you will not receive any alerts.</p>

Problem	Solution
How can I receive warnings only and not watches or statements?	Selective filtering of statements, watches, and warnings is not possible. You will always receive all three levels.
The ER-V1 is locked up and will not respond to commands. How do I reset it?	Press the reset button with a paperclip.
The display fades when placed in direct sunlight.	If the display heats up outside the operational range, the display will fade. For solar charging, partial sunlight or shade is sufficient.
The ER-V1 exits the alert mode and displays time.	The weather alert mode consumes a significant amount of power because it is constantly scanning for the emergency 1050 Hz tone from the National Weather Service. We recommend connecting the power input to a USB computer port or the USB to AC converter for continuous alert operation (reference Section 12). Otherwise, you must rely on hand crank power in this mode.
The ER-V1 does not fully charge with the solar panel .	The solar panel will not completely charge the emergency radio and is intended to extend the existing battery charge. The solar panel efficiency is significantly impacted by direct vs. indirect sunlight, angle of the solar panel, angle of the sun, and weather conditions, including your latitude, time of year (winter vs. summer), time of day, and cloud cover.

11. Liability Disclaimer

- Please help in the preservation of the environment and return used batteries to an authorized depot.
- The electrical and electronic wastes contain hazardous substances. Improper disposal of electronic waste could damage the environment.
- Reading the “User Manual” is highly recommended.
- The specifications of this product may change without prior notice.
- This product is not a toy. Keep out of the reach of children.
- No part of this manual may be reproduced without written authorization of the manufacturer.

BTECH WILL NOT ASSUME LIABILITY FOR INCIDENTAL, CONSEQUENTIAL, PUNITIVE, OR OTHER SIMILAR DAMAGES ASSOCIATED WITH THE OPERATION OR MALFUNCTION OF THIS PRODUCT.

12. Warranty Information

BTECH Electronics provides a 1-year limited warranty on this product against manufacturing defects in materials and workmanship.

This limited warranty begins on the original date of purchase, is valid only on products purchased and only to the original purchaser of this product. To receive warranty service, the purchaser must contact BTECH Electronics for problem determination and service procedures.

Warranty service can only be performed by BTECH Electronics. The original dated bill of sale must be presented upon request as proof of purchase.

Your BTECH Electronics warranty covers all defects in material and workmanship with the following specified exceptions:

- (1) Damage caused by accident, unreasonable use or neglect (lack of reasonable and necessary maintenance).
- (2) Damage resulting from failure to follow instructions contained in your owner's manual.
- (3) Damage resulting from the performance of repairs or alterations by someone other than an authorized BTECH Electronics service center.
- (4) Applications and uses that this product was not intended.
- (5) The products inability to receive a radio signal due to any source of interference, metal obstructions or other reception issues.

This warranty covers only actual defects within the product itself and does not cover the cost of installation or removal from a fixed installation, normal set-up or adjustments, claims based on misrepresentation by the seller or performance variations resulting from installation-related circumstances.

13. FCC Statement

The ER-V1 complies with Part 15 of the FCC Rules. Operation is subject to the following two conditions:

- (1) The ER-V1 must not cause harmful interference, and
- (2) The ER-V1 must accept any interference received, including interference that may cause undesired operation.

NOTE: This equipment has been tested and found to comply with the limits for a Class B digital device, pursuant to Part 15 of the FCC Rules. These limits are designed to provide reasonable protection against harmful interference in a residential installation. This equipment generates, uses and can radiate radio frequency energy and, if not installed and used in accordance with the instructions, may cause harmful interference to radio communications. However, there is no guarantee that interference will not occur in a particular

installation. If this equipment does cause harmful interference to radio or television reception, which can be determined by turning the equipment off and on, the user is encouraged to try to correct the interference by one or more of the following measures:

- Reorient or relocate the receiving antenna.
- Increase the separation between the equipment and receiver.
- Connect the equipment into an outlet on a circuit different from that to which the receiver is connected.
- Consult the dealer or an experienced radio/TV technician for help

14. Battery Recycle Statement



Recycle Rechargeable Batteries

Recycle your old rechargeable batteries at one of the many collection sites in the U.S. and Canada. To find the site nearest you, visit www.call2recycle.org or call toll-free 1-877-2-RECYCLE.